

use & care guide

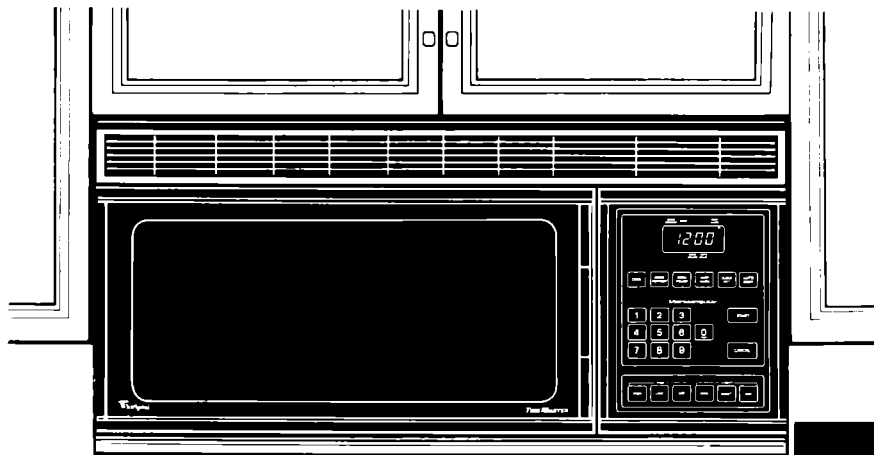

MICROWAVE HOOD COMBINATION



Whirlpool

**Model MH6600XV
Model MH6600XW**

Freezers. Ice Makers. Dishwashers. Built-In Ovens and Surface Units. Ranges. Microwave Ovens. Trash Compactors. Room Air Conditioners. Dehumidifiers. Automatic Washers. Clothes Dryers. Freezers. Ref

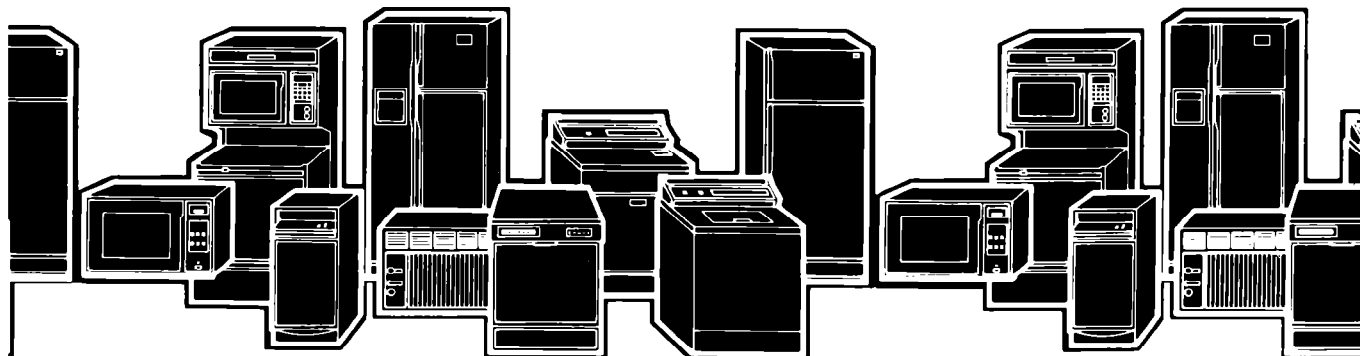

Contents

	Page		Page
Parts and Features	2	Defrosting	10
Before You Install Your Microwave Oven	3	Using KEEP WARM	14
Before You Use Your Microwave Oven	3	Using AUTO START	15
Precautions to Avoid Possible Exposure to Excessive Microwave Energy	3	Other Operating Hints	17
Important Safety Instructions	4	Minute Timer	18
Using Your Microwave Oven	5	Bi-Level Cooking Rack	19
Microwave Oven Controls	5	Caring for Your Microwave Oven	19
Audible Signals	6	Cleaning the Microwave Oven	19
Setting the Clock	6	Cleaning the Grease Filters	19
Cooking in Your Microwave Oven	7	Replacing the Cooktop and Oven Lights	20
Cooking at High Cook Power	7	Operating Safety Precautions	22
Cooking at Lower Cook Powers	8	If You Need Service or Assistance	24
		Microwave Oven Warranty	28

©1988 Whirlpool Corporation

Parts and features

Model MH6600XV

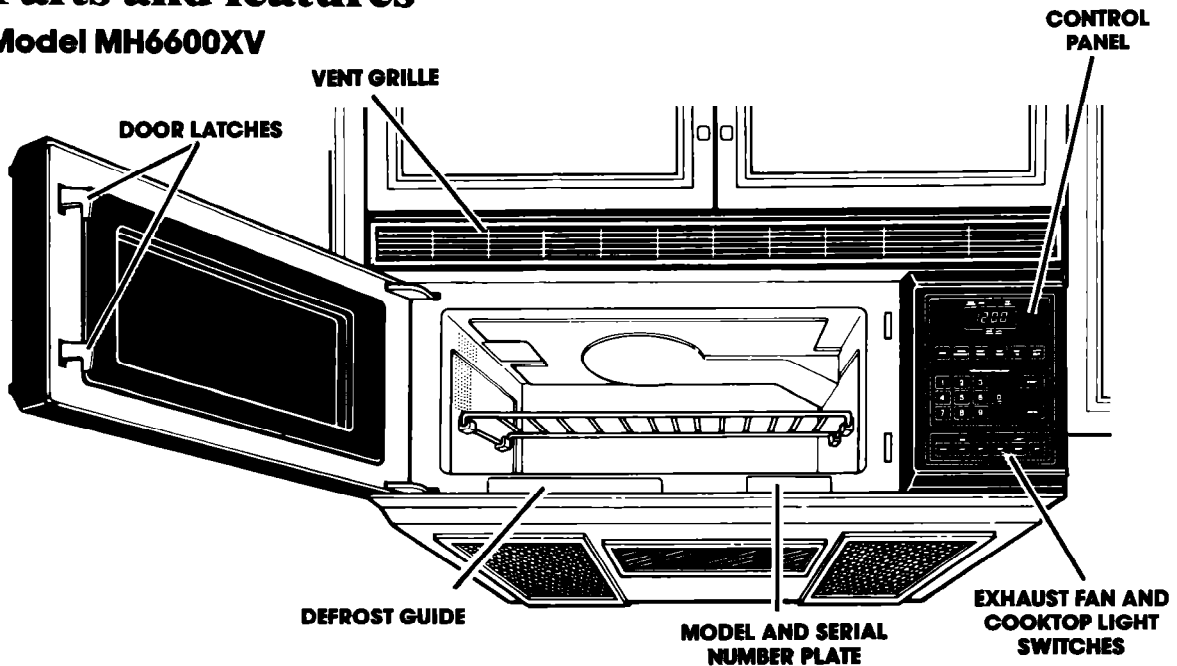

Thank you for buying a Whirlpool appliance. Please complete and mail the Owner Registration Card provided with this product. Then complete the form below. Have this information ready if you need service or call with a question.

- Copy model and serial numbers from plate (behind the microwave oven door on the oven frame) and the purchase date from the sales slip.
- Keep this book and your sales slip together in a handy place.

Model Number _____

Serial Number _____

Purchase Date _____

Service Company Phone Number _____

Fill out and return the Microwave Registration Card included with your oven. If the card is missing, please send the model number and serial number of your microwave oven with your name and address to...

Whirlpool Corporation
Microwave Registration Department
Administrative Center
2000 M-63
Benton Harbor, Michigan 49022

This information will help us reach you if there is ever a need to pass along information about your microwave oven.

Before you install your microwave oven

Read and carefully follow the **INSTALLATION INSTRUCTIONS** packed with your oven.



WARNING: Failure to follow the installation instructions could lead to product malfunction or possible personal injury.

Before you use your microwave oven

Read this Use & Care Guide carefully for important use and safety information. Store in a convenient place for future use.

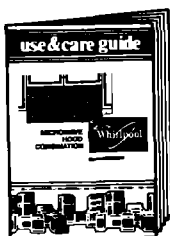

It is your personal responsibility and obligations to be sure your microwave oven:

- Has been installed where it is protected from the weather. **The microwave oven should be at a temperature above 50°F (10°C) for proper operation.**
- Has been properly connected to electrical supply and grounded. (See Installation Instructions.)
- Is not used by children or anyone unable to operate it properly.
- Is properly maintained.
- Is used only for jobs expected of a home microwave oven.

PRECAUTIONS TO AVOID POSSIBLE EXPOSURE TO EXCESSIVE MICROWAVE ENERGY...

DO NOT attempt to operate this oven with the door open since open-door operation can result in harmful exposure to microwave energy. It is important not to defeat or tamper with the safety interlocks.

DO NOT place any object between the oven front face and the door or allow soil or cleaner residue to accumulate on sealing surfaces.

DO NOT operate the oven if it is damaged. It is particularly important that the oven door close properly and that there is no damage to the

- (1) Door (bent),
- (2) Hinges and latches (broken or loosened),
- (3) Door seals and sealing surfaces.

DO NOT operate the microwave oven if the door window is broken.

The microwave oven should be checked for microwave leakage by qualified service personnel after a repair is made.

The oven should not be adjusted or repaired by anyone except properly qualified service personnel.

DO NOT operate the microwave oven with the outer cabinet removed.

IMPORTANT SAFETY INSTRUCTIONS

Microwave ovens have been thoroughly tested for safe and efficient operation. However, as with any appliance, there are special installation and safety precautions which must be followed to ensure safe and satisfactory operation and prevent damage to the unit.



WARNING: To reduce the risk of burns, electric shock, fire, injury to persons or exposure to excessive microwave energy:

1. Read all instructions before using appliance.
2. Read and follow the specific **"PRECAUTIONS TO AVOID POSSIBLE EXPOSURE TO EXCESSIVE MICROWAVE ENERGY"** found on page 3.
3. This appliance must be grounded. Connect only to properly grounded outlets. See **"GROUNDING INSTRUCTIONS"** found in the Installation Instructions.
4. Install or locate this appliance only in accordance with the separately provided **Installation Instructions**.
5. Some products such as whole eggs and sealed containers – for example, closed glass jars – may explode and should not be heated in this oven.
6. Use this appliance only for its intended use as described in this manual.
7. As with any appliance, close supervision is necessary when used by children.
8. Do not operate this appliance if it has a damaged cord or plug, if it is not working properly, or if it has been damaged or dropped. Electric shock, fire or other hazards may result.
9. This appliance should be serviced only by qualified service personnel. Call a Whirlpool authorized TECH-CARE® Service Company for examination, repair or adjustment.
10. Do not cover or block any opening on the appliance, for fire may result.
11. Do not use outdoors for damage to the oven or electric shock may result.
12. Do not immerse cord or plug in water for electric shock may result.
13. Keep cord away from heated surfaces for electric shock may result.
14. Do not let cord hang over edge of table or counter for electric shock may result.
15. See door surface cleaning instructions on page 19.
16. To reduce the risk of fire or fire in the oven cavity:
 - a. Do not overcook food. Carefully attend appliance if paper, plastic, or other combustible materials are placed inside the oven to facilitate cooking. Paper can char or burn, and some plastics can melt if used when heating foods.
 - b. Test dinnerware or cookware before using. See page 24. Some dishes (melamine, Centura,® etc.) absorb microwave energy, becoming too hot to handle and slowing cooking times. Remove wire twist-ties from paper or plastic bags before placing bag in oven. Cooking in metal containers can damage the oven. So can containers with hidden metal (twist-ties, foil lining, staples, metallic glaze or trim.)
 - c. If materials inside the oven should ignite, keep oven door closed, turn oven off, and disconnect the power cord, or shut off power at the fuse or circuit breaker panel.
17. Read and follow **"Operating Safety Precautions"** starting on page 22.
18. Because of the automatic exhaust fan feature, the following cautions must be observed:
 - a. Do not leave the area when using your cooktop at a high setting. Accidental fires from boil-overs or spattering on the surface unit could spread, especially if the exhaust fan is operating.
 - b. Do not allow grease and soil to build up in the grease filter. Exhaust fan efficiency will decrease and fire may result. Clean often following the filter cleaning instructions on page 19.
 - c. Do not flame foods when operating the exhaust fan. The fan, if operating, may spread the flame and cause personal injury or property damage.

Using your microwave oven

Microwave Oven Controls

There are four parts in the control section:

- The Digital Display/Clock and Indicator Lights
- Command Pads
- Number Pads
- Fan and Light Pads

Instructions for each control are covered on the following pages. Read them carefully.

When you first plug in the oven, a tone sounds and the Display will show 88:88. If after you set the Clock (page 6), the Display again shows all 8's; your electricity was off for a while. Reset the Clock.

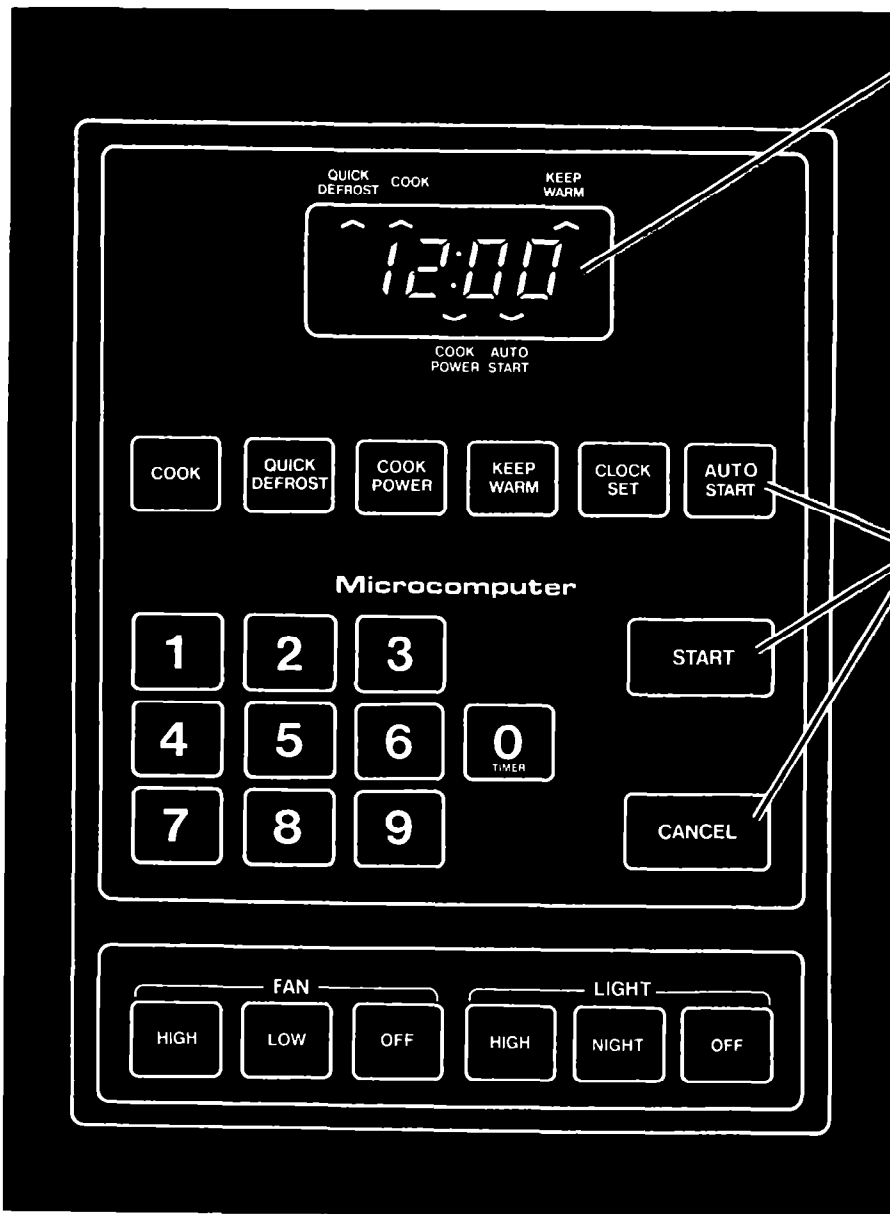

Digital Display/Clock and Indicator Lights

When you are not using the microwave oven, it is an accurate Digital Clock. When you are using the microwave oven, it displays time settings, Indicator Lights and shows you what Number Pads you touched.

Command Pads

Touch Command Pads to tell the microwave oven what to do and in what order. A few examples:

- CLOCK SET tells the oven you are going to set the clock.
- START tells the oven to start.

See page 6 for information on the tone you hear when touching any pad.

Each Command Pad (except START and CANCEL) lights an Indicator Light on the digital display.

Number Pads

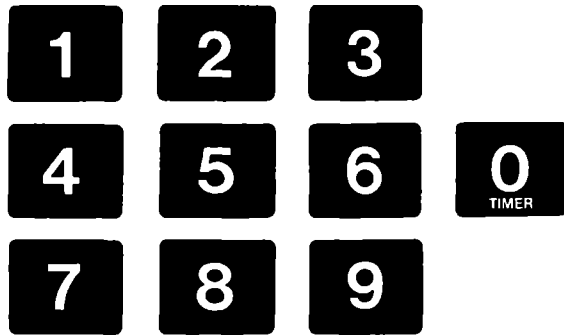

Once you've touched a Command Pad to tell the oven what you want it to do, you'll touch Number Pads to tell it...

- a time.
- a Cook Power.
- a food temperature.

Fan and Light Pads

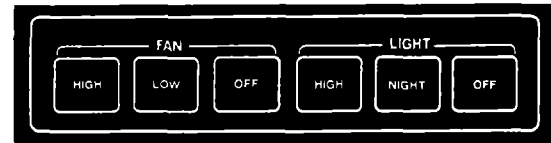

The six pads at the bottom of the control panel control the 2-Speed Exhaust Fan and the Cooktop Light.

Touch Fan Pad for the desired fan speed. **(NOTE: If the temperature gets too hot around the microwave oven, the exhaust fan in the vent hood will automatically turn on or change to the HIGH setting to protect the oven. It may stay on up to an hour to cool the oven. When this occurs, the Fan Pad will not turn the fan off.)**

Touch Light Pad for the desired cooktop or countertop lighting.

Audible Signals

Audible signals are available to guide you when setting and using your oven. (A programming tone will sound each time you touch a pad. Two beeps will sound between cycles. A reminder tone will sound every 30 seconds after cooking is done to remind you that something has been left in the oven. A 3 second tone signals the end of the Minute Timer function.) If you don't hear a tone, it is because of incorrectly entered instructions or because the tones have been removed. For example, a tone will not sound if you touch a Number Pad before you touch a Command Pad.

To remove the programming tone and reminder tone:

- Open the door.
- Touch CANCEL **twice**, then touch START.
- Programming and reminder tones will be cancelled.

To replace the tones:

- Repeat the steps above.

To remove all tones, except the Minute Timer signal:

- Open the door.
- Touch CANCEL **twice**, touch 0, then touch START.
- All audible tones (except Minute Timer signal) will be cancelled.

To replace the tones:

- Repeat the steps above.

Setting the Clock

When the oven is first plugged in, a tone sounds and the Display shows "88:88." If the electric power ever goes off, the Display will again show all 8's when the power comes back on.

You can cook or use the Minute Timer without setting the Clock, but the Display will be blank after cooking.

DO THIS...



1. Touch CLOCK SET.

THIS HAPPENS...

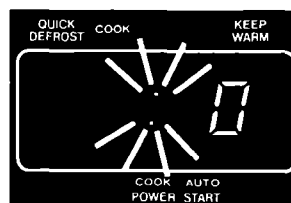

The Display will show a "0" and the colon will start to flash. **The first Number Pad must be touched within 5 seconds or the Display will go blank.** Touch CLOCK SET again and continue.

3 **2** **5**

2. Touch Number Pads for the correct time of day.

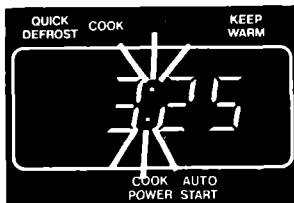

The Display will show what numbers you touched **in the order you touched them**. This example shows 3:25.

START

3. Touch START.



The colon will stop flashing. The Clock is set.



If you have touched in an incorrect time, such as 12:65, "Err" will show on the Display. Touch CLOCK SET and start over.

NOTE: To reset the Clock, touch CLOCK SET. The current time will show on the Display and the colon will flash. Continue to set the Clock as shown above.

Cooking in Your Microwave Oven

Be sure to read the MICRO MENUS® Cookbook packed with the microwave oven. It contains information about:

- What microwave energy is.
- How food is cooked by microwave energy.
- What affects cooking speed and cooking evenness.
- Safety tips.
- Utensils to use when cooking in a microwave oven.
- Cooking times for different foods.

Important things to remember to get the best cooking results.

- ALWAYS cook food for the minimum recommended cooking time. If necessary, add time in one or two minute periods, then check for doneness to avoid overcooking the food.
- Stir, turn or rearrange the food being cooked about halfway through the cooking time for most even doneness with all recipes.
- If a glass cover is not available, use waxpaper, paper towels or microwave approved plastic wrap. Turn back a corner to vent steam during cooking.

Cooking at High Cook Power

Follow these steps to cook at HIGH power.

DO THIS...

THIS HAPPENS...

1. Put food in the oven and close the door.

COOK

2. Touch COOK.

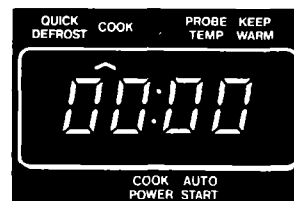

The COOK Indicator Light will come on and the Display will show four 0's.

continued on next page 7



3. Touch Number Pads for cooking time you want.



The display will show the numbers you touched **in the order you touched them**. The example shows 1 minute, 30 seconds.



4. Touch START.



The oven will automatically cook at HIGH Cook Power.

The COOK Indicator Light will stay on to show that the oven is cooking in the cycle.

The Display counts down the time to show how much cooking time is left.

count
down



When the cooking time ends, "End" will show on the Display and 4 beeps will sound. (You can stop the beeping by opening the door or by touching CANCEL.) "End" will remain on the Display and a reminder tone will sound every 30 seconds until the door is opened or CANCEL is touched. The Display will then show the time of day.

BEEP BEEP BEEP BEEP

Changing the Cooking Time

Cooking time can be changed any time before touching START or during the cycle:

1. Touch COOK.
2. Touch numbers for the new time.
3. Touch START.

Cook will continue cooking for the new time.

Cooking at Lower Cook Powers

For best results, some recipes call for lower Cook Powers. The lower the Cook Power, the slower the cooking. Each Number Pad also stands for a different percentage of Cook Power. Many recipes in your MICRO MENUS® Cookbook tell you, by number, which Cook Power to use. Recipes in other books and magazines may tell you by name (HI, MED, LO, etc.) or percentage (10%, 50%, 80%, etc.).

The following chart gives the percentage of Cook Power each Number Pad stands for, and Cook Power name usually used.

automatic 100% of full power	HIGH	4 = 40% of full power
9 = 90% of full power		3 = 30% of full power
8 = 80% of full power		MED-LOW
7 = 70% of full power	MED-HIGH	2 = 20% of full power
6 = 60% of full power		1 = 10% of full power
5 = 50% of full power	MED	0 = no power (fan and light will be off)

DO THIS...

THIS HAPPENS...

1. Put food in the oven and close the door.



The COOK Indicator Light will come on and the Display will show four 0's.

2. Touch COOK.

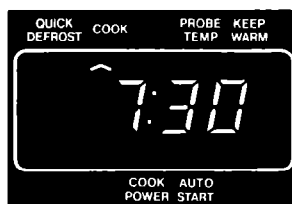

The Display will show the numbers you touched **in the order you touched them**. This example shows 7 minutes, 30 seconds.

3. Touch Number Pads for the cooking time you want.



The COOK POWER Indicator Light will come on and the Display will show "P-HI." This shows the oven is pre-programmed to cook at full (HIGH) power.

4. Touch COOK POWER.



The Display will show what you touched. This example shows you touched Number Pad 5 for 50% of full power.

5. Touch a Number Pad for the Cook Power you want.

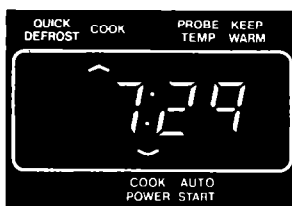

The COOK and COOK POWER Indicator Lights will stay on to show that the oven is cooking at a Cook Power other than HIGH.

6. Touch START.

count down

The Display counts down the time to show how much cooking time is left in the first cycle.



For 2 of every 10 seconds, the Display will show the Cook Power you selected.

BEEP BEEP BEEP BEEP

When the cooking time ends, "End" will show on the Display and 4 beeps will sound. (You can stop the beeping by opening the door or by touching CANCEL.) "End" will remain on the Display and a beep will sound every 30 seconds until door is opened or CANCEL is touched. The Display will then show the time of day.

Changing the Cook Power

The Cook Power can be changed any time before touching START or during the cycle.

- Touch COOK POWER.
 - Touch a number for the new Cook Power.
 - Touch START. The cycle will cook at the new Cook Power for the original time.
- OR...**
- Touch COOK POWER **twice** if you want to change a lower Cook Power to HIGH.
 - Touch START.

Defrosting

Use QUICK DEFROST to thaw frozen food before cooking. For suggested defrost times, see the guide behind the oven door or in your MICRO MENUS® cookbook.

DO THIS...

THIS HAPPENS...

1. Put frozen food in the oven and close the door.

QUICK DEFROST

2. Touch **QUICK DEFROST**.



The QUICK DEFROST Indicator Light will come on and the Display will show four 0's.

3. Touch Number Pads for the defrosting time you want.

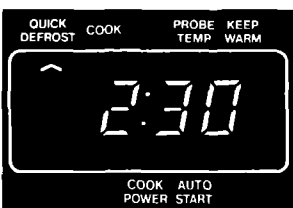

The Display will show the number you touched **in the order you touched them**. This example shows 2 minutes, 30 seconds.

4. Touch **START**.



The QUICK DEFROST Indicator Light will stay on to show that the oven is in the Quick Defrost Cycle.

count down

The Display counts down the time to show how much defrosting time is left.



BEEP BEEP BEEP BEEP

When the defrost time ends, "End" will show on the Display and 4 beeps will sound. (You can stop the beeping by opening the door or by touching CANCEL.) "End" will remain on the Display and a beep will sound every 30 seconds (to remind you that food is in the oven) until door is opened or CANCEL is touched. The Display will then show the time of day.

Standing Time

For best results, allow the food to stand for a while after defrosting. This helps equalize the temperature of the food to provide more even defrosting.

When the COOK cycle follows QUICK DEFROST, the oven automatically provides a standing time equal to the time touched in for QUICK DEFROST. The COOK Cycle will begin after the automatic standing time. There is no standing time between QUICK DEFROST and KEEP WARM.

About the QUICK DEFROST Cycle

The microwave oven automatically divides the time set for the QUICK DEFROST Cycle into three equal parts:

First part	80% of full Cook Power
Second part	50% of full Cook Power
Third part	20% of full Cook Power

This automatic step-down in Cook Power helps defrost food quickly and completely.

Changing or Adding Defrost Time

You can change the defrosting time any time before or after touching START.

- Touch QUICK DEFROST.
- Touch numbers for new time.
- Touch START.

Any new time setting made while QUICK DEFROST is operating will continue the defrosting at only 20% of full power.

The best time to change the setting is near the end of the QUICK DEFROST Cycle.

- Open the door.
- Check the food with long-tined fork; if center area is hard frozen, set additional time.
Remember that standing time is necessary to complete defrosting.
- Close the door and touch START to continue the cycle if no additional time is needed.
OR...
- Touch in new instructions for additional defrosting time.

Cooking Automatically After Defrosting

The controls can be set so the microwave oven goes automatically from defrosting to the Cook cycle you have touched in.

DO THIS...

THIS HAPPENS...

1. Put food in the oven and close the door.

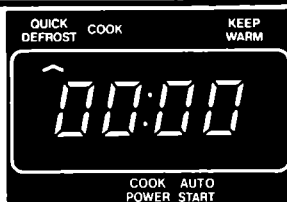

The QUICK DEFROST Indicator Light will come on and the Display will show four 0's.

2. Touch QUICK DEFROST.



The Display will show the numbers you touched **in the order you touched them**. This example shows 2 minutes, 30 seconds.

3. Touch Number Pads for the defrosting time you want.

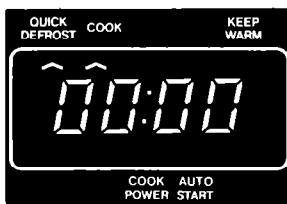

The COOK Indicator Light will come on and the Display will show four 0's.

4. Touch COOK.

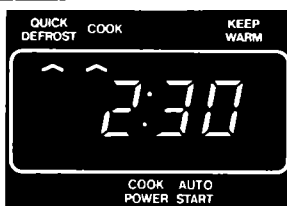

The Display will show the numbers you touched **in the order you touched them**. This example shows 2 minutes, 30 seconds.

5. Touch Number Pads for the cooking time you want.

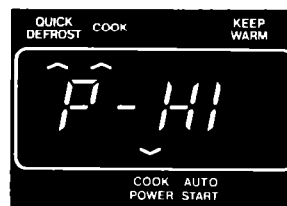

The COOK POWER Indicator Light will come on and the Display will show "P-HI." This shows the oven is preprogrammed to cook at full (HIGH) power.

6. Touch COOK POWER.
(Option: Touch START if you want to use HIGH power.)

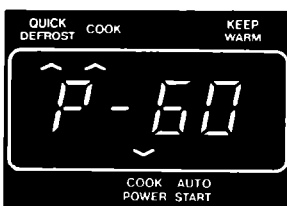

The Display will show what you touched. This example shows you touched Number Pad 6 for 60% of full power.

7. Touch a Number Pad for the Cook Power you want.

START

8. Touch START.



count down

BEEP BEEP



count down

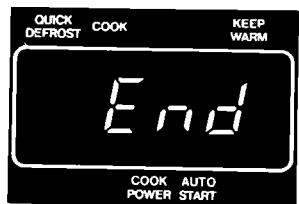

BEEP BEEP BEEP BEEP

When you touch START, the QUICK DEFROST Indicator Light will stay on. All other Indicator Lights will go off. The Display counts down the time to show how much time is left in the Defrost cycle.

When the defrost time ends, the microwave oven automatically lets the food stand for the **same amount of time used for defrosting**. The QUICK DEFROST Indicator Light stays on and the Display counts down the standing time. **During the countdown the oven will be dark, and the fan will be off.**

When the standing time is over, you will hear 2 beeps and the Cook cycle will start.

The COOK Indicator Light will be on during the Cook cycle. The COOK POWER Indicator Light will also be on **if you are using a Cook Power other than HIGH.**

The Display counts down the time to show how much time is left in the second cycle.

For 2 of every 10 seconds, the Display will show the Cook Power you selected, if you are using a Cook Power other than high.

When the Cook cycle ends, "End" will show on the Display and 4 beeps will sound. (You can stop the beeping by opening the door or by touching CANCEL.) "End" will remain on the Display and a beep will sound every 30 seconds until door is opened or CANCEL is touched. The Display will then show the time of day.

Using KEEP WARM

Hot, cooked foods can be safely kept warm in your microwave oven for up to 99 minutes, 99 seconds (about 1 hour, 40 minutes). KEEP WARM can be used by itself, or it can automatically follow a cooking cycle.

DO THIS...

THIS HAPPENS...

1. Put cooked, hot food in oven and close door.



2. Touch KEEP WARM.



The KEEP WARM Indicator Light will come on. The Display will show the time of day.



3. Touch START.



The KEEP WARM Indicator Light will stay on. The oven light and the fan will come on. The Display will continue to show the time of day.

- KEEP WARM operates for up to 99 minutes, 99 seconds.
- Opening the oven door cancels KEEP WARM. Close the door and touch KEEP WARM, then START if additional KEEP WARM time is desired.
- Foods cooked covered should be covered during KEEP WARM.
- Pastry items (pies, turnovers, etc.) should be uncovered during KEEP WARM.
- Complete meals kept warm on a dinner plate should be covered during KEEP WARM.
- The use of more than one complete KEEP WARM (about 1 hour, 40 minutes) is not recommended. The quality of some foods will suffer with extended time.

To Automatically Follow Another Cycle

- **While you are touching in cooking instructions**, touch KEEP WARM before touching START, **OR...**
- **After the oven starts operating**, touch KEEP WARM and then START.
- When the last cooking cycle is over, you will hear 4 beeps. The KEEP WARM Indicator Light will come on and the time of day will be displayed while the oven continues to run.
- KEEP WARM will follow QUICK DEFROST or COOK.

Using AUTO START

The microwave oven can be set to start automatically at a later time. Use AUTO START to delay the start of cooking for up to 11 hours, 59 minutes.

DO THIS...

THIS HAPPENS...

1. Make sure the Clock is set to correct time of day. See page 6 if any change is needed.

2. Put food in oven and close the door. (See CAUTION on page 17.)



3. Touch AUTO START.

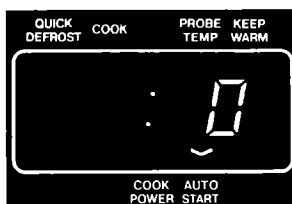

The AUTO START Indicator Light will come on and the Display will show a "0."



4. Touch Number Pads for the time of day you want cooking to start.



The Display will show the numbers you touched **in the order you touched them**. This example shows 5 o'clock.



5. Touch COOK.



The COOK Indicator Light will come on and the Display will show four 0's.



6. Touch Number Pads for the cooking time you want.



The Display will show the numbers you touched **in the order you touched them**. This example shows 8 minutes, 30 seconds.

continued on next page

**COOK
POWER**

**7. Touch COOK POWER. (Option:
Skip to Step 9 if you want to use
HIGH power.)**

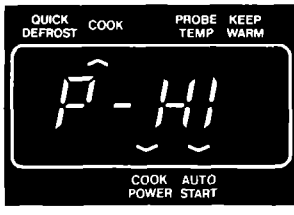

The COOK POWER Indicator Light will come on and the Display will show "P-HI." This shows the oven is pre-programmed to cook at full (HIGH) power.

7

**8. Touch a Number Pad for
the Cook Power you want.**



The Display will show what you touched. This example shows you touched Number Pad 7 for 70% of full power.

START

9. Touch START.



The AUTO START Indicator Light will stay on. All other Indicator Lights will go off. The Display will go back to showing the time of day.

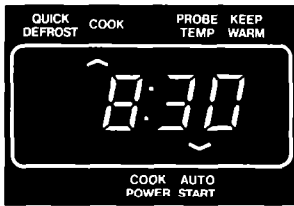

When the time of day reaches the time you have set in AUTO START, the AUTO START Indicator Light will go off, the COOK and COOK POWER Indicator Lights will come on, the cooking time will show on the Display, and the oven will start cooking.

*count
down*

The Display counts down the time to show how much time is left.



For 2 of every 10 seconds the Display will show the Cook Power you selected. If you are using a Cook Power other than HIGH.



BEEP BEEP BEEP BEEP

When the cooking time ends, "End" will show on the Display and 4 beeps will sound. (You can stop the beeping by opening the door or by touching CANCEL.) "End" will remain on the Display and a beep will sound every 30 seconds until door is opened or CANCEL is touched. The Display will then show the time of day.

Note: If the oven light and fan come on when you touch START, the Start Time has not been set correctly. Open and close door, reprogram AUTO START time, then touch START.

Additional information

- Additional cycles can be set when using AUTO START. Follow instructions under the proper heading (Defrosting, Using KEEP WARM) either before or after you touch START.
- You can change times, or add cycles at any time during the AUTO START cycle.
 1. Touch the COOK Cycle you wish to change or add.
 2. Touch numbers for new time.
 3. Touch COOK POWER, if desired.
 4. Touch number for new Cook Power, or touch COOK POWER again if high is desired.
 5. Touch START.
- Opening the door does not stop Auto Start operation.
- When the door is opened, and the food is taken out during the AUTO START operation, the CANCEL key must be touched to stop AUTO START operation.

CAUTION:

Use foods that will not go bad or spoil while waiting for cooking to start. Avoid using with milk or eggs, cream soups, cooked meats, poultry or fish, or any item with baking powder or yeast.

Smoked or frozen meats may be used; so can vegetables, fruits and casserole-type foods.

Any food that has to wait for cooking to start should be very cold or frozen before it is put in the oven. MOST UNFROZEN FOODS SHOULD NEVER STAND AT ROOM TEMPERATURE MORE THAN TWO HOURS BEFORE COOKING STARTS.

Other Operating Hints

1. To double check settings while the oven is running:

- Touch the Command Pad for the setting you want to check. The instruction programmed for that pad will show on the Display for 5 seconds. The Display returns to showing what the oven is doing.

2. To stop the oven while it is running:

- Open the door. The oven will stop. Restart the oven by closing the door and touching START.
- Touch CANCEL. All instructions will be erased. You must touch in new instructions.



3. If you touch two instructions into the same cycle, the second set of instructions will cancel the first.

Minute Timer

The microwave oven controls can be used as a kitchen timer. Use COOK at "0" Cook Power for timing up to 99 minutes, 99 seconds.

DO THIS...

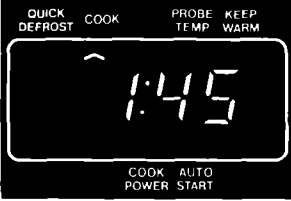
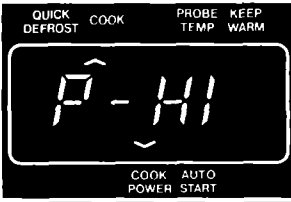
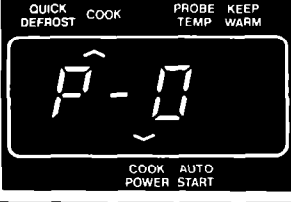
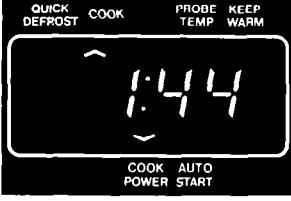
THIS HAPPENS...

<p>COOK</p> <p>1. Touch COOK.</p>		<p>The COOK Indicator Light will come on and the Display will show four 0's.</p>
<p>1 4 5</p> <p>2. Touch Number Pads for the minutes and seconds you want.</p>		<p>The Display will show what numbers you touched in the order you touched them. This example shows 1 minute, 45 seconds.</p>
<p>COOK POWER</p> <p>3. Touch COOK POWER.</p>		<p>The COOK POWER Indicator Light will come on and the Display will show "P-HI"</p>
<p>0 TIMER</p> <p>4. Touch "0" Number Pad.</p>		<p>The Display will show "P-0." This tells you that the oven will be operating at 0% power.</p>
<p>START</p> <p>5. Touch START.</p> <p>NOTE: If you hear the fan start when you touch START, you have not set the time properly. Touch CANCEL and start over.</p>	  <p>BEEP BEEP BEEP BEEP</p>	<p>The COOK Indicator Light will stay on to show that the timer is running. The Cook Power Indicator Light will be off.</p> <p>The Display counts down to show you how much time is left. During the count-down the oven will be dark and the fan will be off.</p> <p>When the set time ends, "End" will show on the Display and 4 beeps will sound. (You can stop the beeping by opening the door or by touching CANCEL.) "End" will remain on the Display and a beep will sound every 30 seconds until door is opened or CANCEL is touched. The Display will then show the time of day.</p> <div style="border: 1px solid black; padding: 5px; margin-top: 10px;"> <p>Opening the oven door stops the countdown. Close the door and touch START to continue the timing countdown.</p> </div>

Bi-level cooking

A removable Bi-Level Cooking Rack is available as an accessory kit. This rack lets you cook or reheat foods together as a meal. Ask your dealer for details on...

- MK800 (832985) – Bi-Level Cooking Rack Kit

Caring for your microwave oven

Cleaning the Microwave Oven

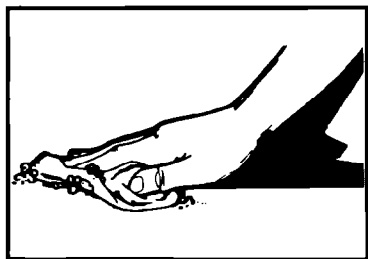

Wipe often with warm soapy water and a soft cloth or sponge.

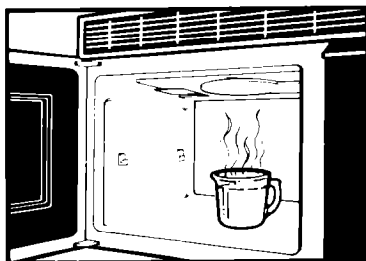

For stubborn soil, boil a cup of water in the oven for 2 or 3 minutes. Steam will soften the soil.

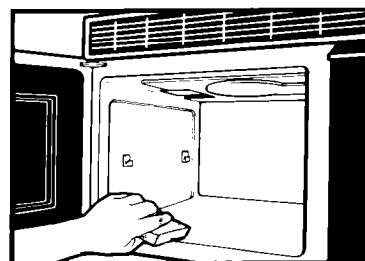

Be sure to clean the areas where the door and oven frame touch when closed.

When cleaning surfaces of door and oven that come together on closing the door, use only mild, non-abrasive soaps or detergents applied with a sponge or soft cloth. Rinse well.

CAUTION:

Abrasive cleansers, steel wool pads, gritty wash cloths, etc., can damage the control panel, and the interior and exterior oven surfaces. Use a soft cloth or a sponge with a mild detergent or spray glass cleaner.

Cleaning the Grease Filters

The grease filters should be removed and cleaned often, at least once a month. **NOTE: If your microwave hood combination has an extra charcoal filter from a Recirculating Kit (4158313), it should be replaced every 6-12 months.**

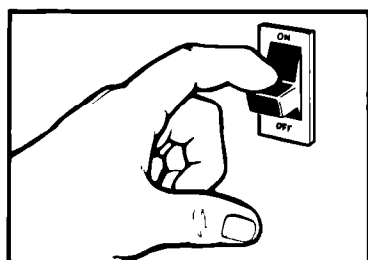

- 1.** For your personal safety, turn off the electric power at the main power supply.

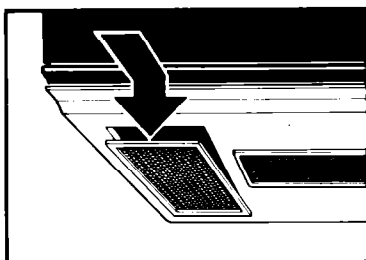

- 2.** To remove grease filters, slide each filter to the rear. Pull filters downward and to the front. The filter will drop out.

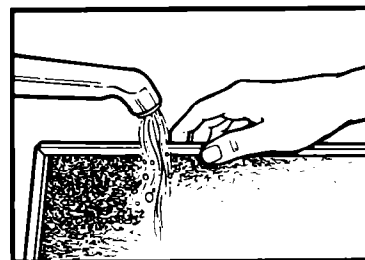

- 3.** Soak filter in hot water and a mild detergent. Scrub and swish to remove embedded dirt and grease. Rinse well and shake to dry. **Do not use ammonia or place in a dishwasher. The aluminum will darken.**

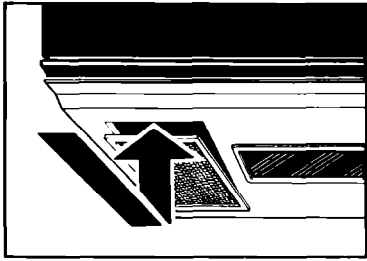

- 4. To replace grease filters:** slide filter in the frame slot on the back of the opening.

Push filter upward and pull to the front to lock into place.

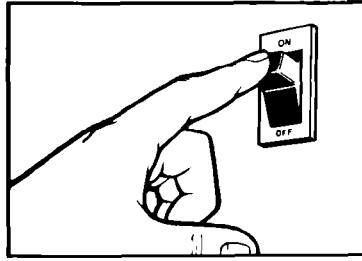

- 5.** Turn the power back on at the main power supply.

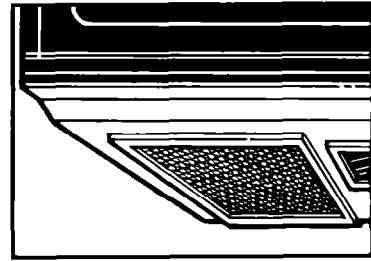



- 6.** Do not operate the hood without the filters in place.

Replacing the Cooktop and Oven Lights

The cooktop and oven lights are 30-watt, candelabra base bulbs. To replace either of these lights, follow these steps:

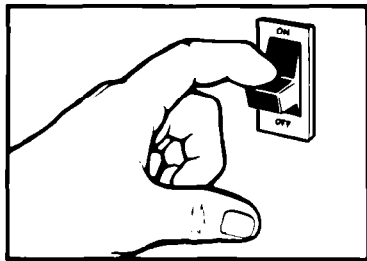
The Cooktop Light:



- 1.**  **WARNING:** To avoid possible electrical shock hazard, unplug or turn off at fuse box or circuit breaker.

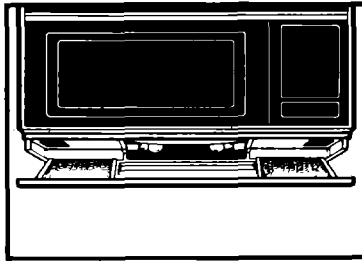

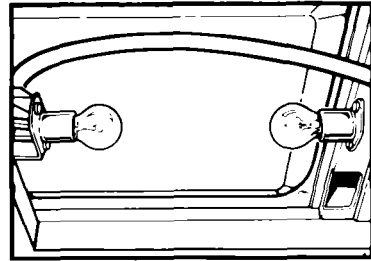

- 2.** Remove the five screws holding the bottom panel in place.
- 3.** Lower the front of the panel. Slide the panel forward to remove.

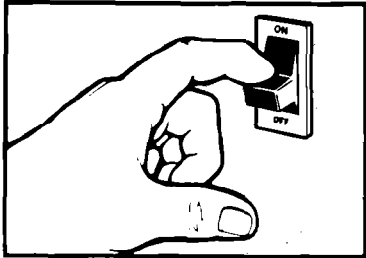

- 4.** Replace the bulb(s).
- 5.** Replace the bottom panel in reverse order.

The Oven Light:



1.  **WARNING: To avoid possible electrical shock hazard, unplug or turn off at fuse box or circuit breaker.**

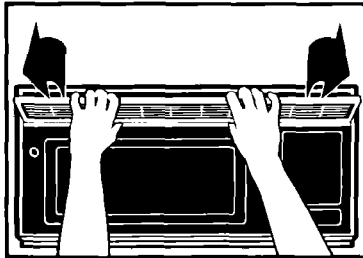

2. Open the microwave oven door.
3. Remove the vent cover mounting screws.
4. Tip the cover forward, then lift out to remove.

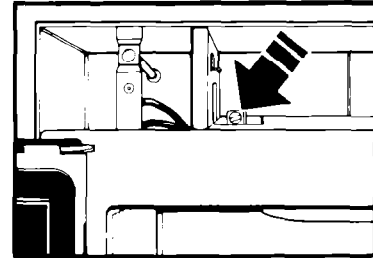

5. Remove bulb holder mounting screw.

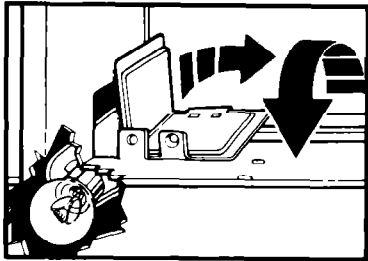

6. Slide bulb holder out, then turn towards front to remove bulb from oven.

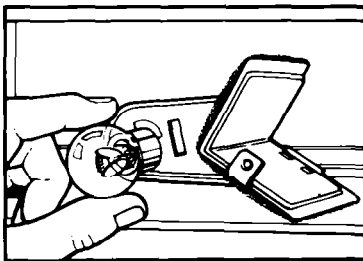

7. Replace bulb.
8. Replace the bulb holder and mounting screw.

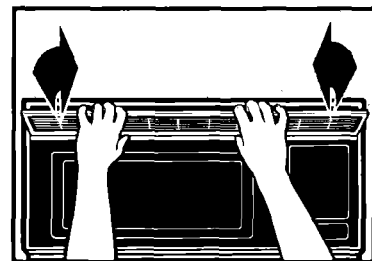

9. Slide the top of the vent cover into place. Push the bottom until it snaps into place. Replace the mounting screws.

Operating safety precautions

WARNING: DO NOT use oven until you have read and understand ALL the information on safe use.

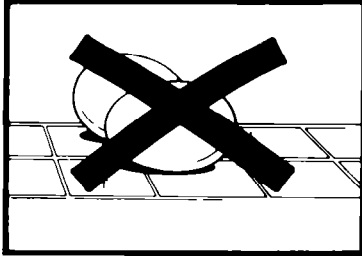

NEVER COOK OR REHEAT A WHOLE EGG.

Steam build-up in whole eggs may cause them to burst and burn you, and possibly damage the oven. Slice hard boiled eggs before heating. In rare instances, poached eggs have been known to explode. Cover poached eggs and allow a standing time of one minute before cutting into them.

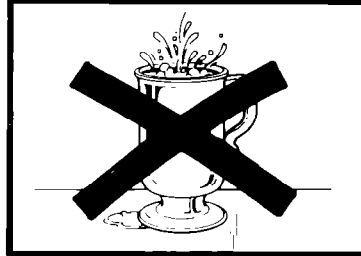

Liquids heated in certain containers (especially cylindrical-shaped containers) may become overheated. The liquid may splash out with a loud noise during or after heating or when adding ingredients (coffee, etc.) resulting in harm to the oven and possible personal injury. For best results stir any liquid several times before heating or reheating.

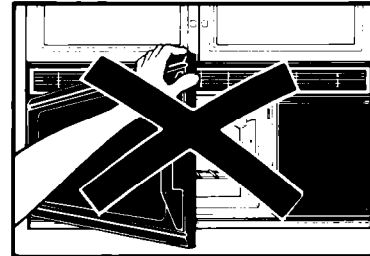

NEVER lean on the door or allow a child to swing on it when the door is open. Injury could result.

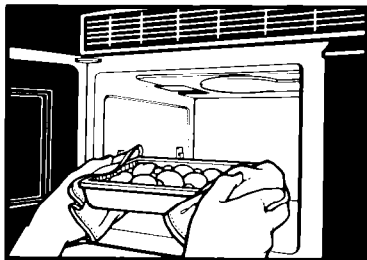

USE HOT PADS. Microwave energy does not heat containers, but the hot food does.

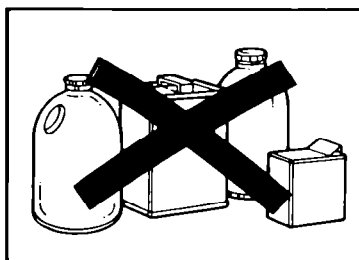

DO NOT heat, store or use flammable, inflammable or corrosive materials in or near the oven.

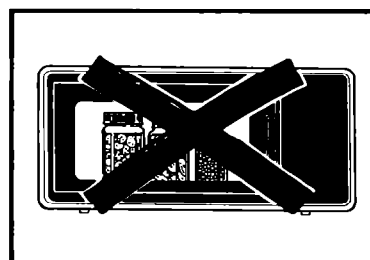

DO NOT can foods in the oven. Closed glass jars may explode resulting in damage to the oven or possible personal injury.

DO NOT use the oven to sterilize objects (baby bottles, etc.). It is difficult to maintain the high temperature required for safe sterilization.

CAUTION: DO NOT use the oven until you have read and understand **ALL** precautions to prevent damage to the oven.

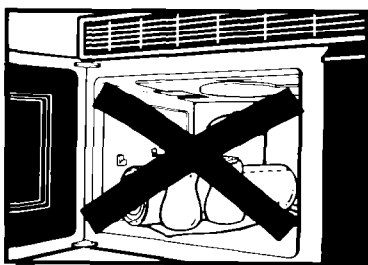

DO NOT use the oven for storage. Do not leave paper products, books or cooking utensils in the oven when not in use. Fire may result if someone accidentally starts the oven. Don't let anything touch the top of the oven.

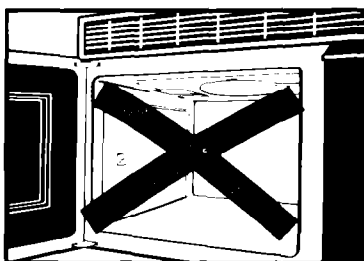

Starting a microwave oven when it's empty is not recommended. If you experiment, put a container of water in the oven.

It is normal for the inside of the oven door to look wavy after the oven has been running for a while.

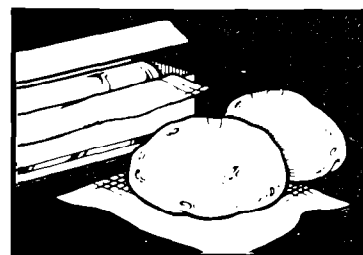

DO NOT OVERCOOK POTATOES. Fire could result. At the end of the recommended cooking time they should be slightly firm. Wrap in foil and set aside for 5 minutes. They will finish cooking while standing.

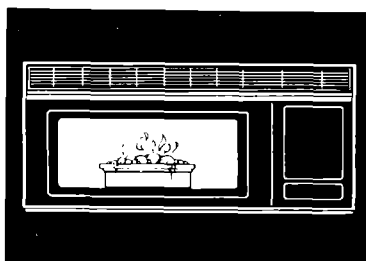

If a fire should start in the oven cavity:

- **keep door closed**
- **turn oven off**
- **disconnect the power supply** at the cord, fuse box or circuit breaker.

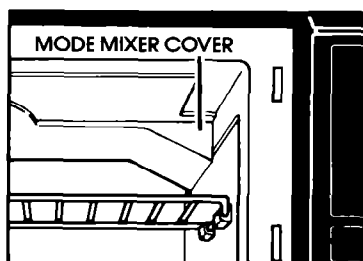

NEVER remove the mode mixer cover. The plastic cover protects the microwave mixer blade from soil or bending.

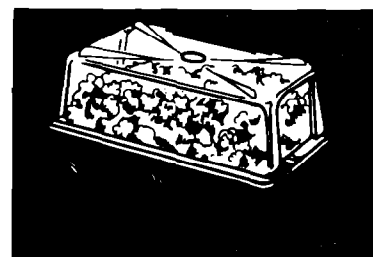

Use of unsuitable containers for popping corn could result in fire or damage to the oven. Make popcorn only in poppers designed for use in microwave ovens. Follow directions supplied with the popper. Results are the manufacturer's responsibility.

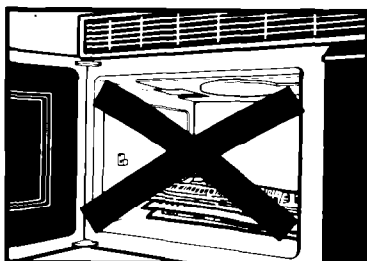

DO NOT use newspaper or other printed paper in the oven. Fire could result.

DO NOT dry flowers, fruit, herbs, wood, paper, gourds or clothes in the oven. Fire or other hazards may result.

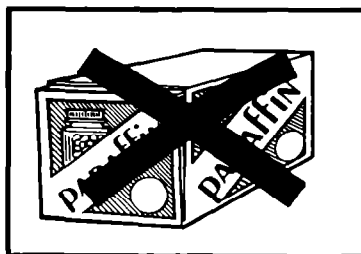

DO NOT try to melt paraffin wax in the oven. Fire or other hazards may result.

General information

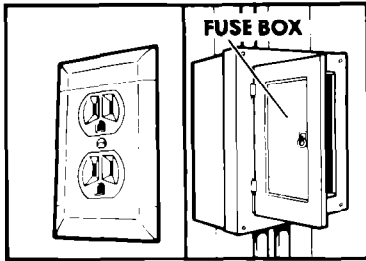

If your electric power line or outlet voltage is less than normal 120 volts, cooking times may be longer.

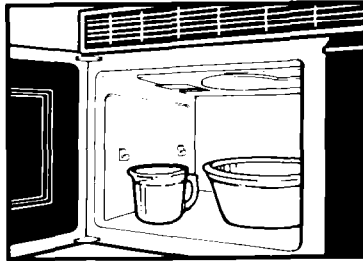

To test a dish for safe use, put it into the oven with a cup of water **beside it**. Cook on HIGH Cook Power for one minute. **If the dish gets hot and water stays cool, do not use it.**

If you need service or assistance, we suggest you follow these five steps:

1. Before calling for assistance...

Performance problems often result from little things you can find and fix yourself without tools of any kind.

If nothing operates:

- Is the oven correctly wired into a live circuit with the proper voltage? See the Installation Instructions.
- Have you checked your home's main fuses or circuit breaker box?
- Have you checked the electric company for a power failure?

If the microwave oven will not run:

- Is the oven being used as a timer?
- Is the door firmly closed and latched?
- Did you touch START?
- Did you follow the directions exactly?

If the microwave cooking times seem too long:

- Is the electric supply to your home or wall outlet low or lower than normal? Your electric company can tell you if the line voltage is low. Your electrician or service technician can tell you if the outlet voltage is low.
- Is the Cook Power at the recommended setting?
- Are you allowing for more time when cooking more food at one time?

If the Display shows a time counting down but the oven is not cooking:

- Is the oven door closed completely?
- Have you set the controls as a kitchen timer?
- Is the oven in standing time between QUICK DEFROST and COOK or AUTO START?

If you do not hear a programming tone (page 6):

- Is the command correct?
- Has the tone been cancelled?

If the fan seems to be running slower than usual:

- Has the oven been stored in a cold area? The fan will run slower until the oven warms up to normal room temperature.

If there has been a power interruption, the Display will show 88:88. Reset the clock, (page 6).

2. If you need assistance*...

Call Whirlpool COOL-LINE® service assistance telephone number. Dial free from anywhere in the U.S.:

1-800-253-1301

and talk with one of our trained consultants. The consultants can instruct you in how to obtain satisfactory operation from your appliance or, if service is necessary, recommend a qualified service company in your area.

3. If you need service*...



Whirlpool has a nationwide network of franchised TECH-CARE® service Companies. TECH-CARE service technicians are trained to fulfill the product warranty and provide after-warranty

service, anywhere in the United States. To locate TECH-CARE service in your area, call our COOL-LINE service assistance telephone number (see Step 2) or look in your telephone directory Yellow Pages under:

APPLIANCES - HOUSEHOLD -
MAJOR - SERVICE & REPAIR

ELECTRICAL APPLIANCES -
MAJOR - REPAIRING & PARTS

OR

WHIRLPOOL APPLIANCES
FRANCHISED TECH-CARE SERVICE

WHIRLPOOL APPLIANCES
FRANCHISED TECH-CARE SERVICE

SERVICE COMPANIES

XYZ SERVICE CO
123 Maple 999-9999

SERVICE COMPANIES

XYZ SERVICE CO
123 Maple 999-9999

OR

WASHING MACHINES, DRYERS
& IRONERS - SERVICING

WHIRLPOOL APPLIANCES
FRANCHISED TECH-CARE SERVICE

SERVICE COMPANIES

XYZ SERVICE CO
123 Maple 999-9999

4. If you have a problem*...

Call our COOL-LINE service assistance telephone number (see Step 2) and talk with one of our consultants, or if you prefer, write to:

Mr. Donald Skinner
Director of Customer Relations
Whirlpool Corporation
2000 M-63
Benton Harbor, MI 49022

5. If you need FSP® replacement parts*...

FSP® is a registered trademark of Whirlpool Corporation for quality parts. Look for this symbol of quality whenever you need a replacement part for your Whirlpool appliance. FSP replacement parts will fit right and work right, because they are made to the same exacting specifications used to build every new Whirlpool appliance.

To locate FSP replacement parts in your area, refer to Step 3 above or call the Whirlpool COOL-LINE service assistance number in Step 2.

* If you must call or write, please provide: model number, serial number, date of purchase, and a complete description of the problem. This information is needed in order to better respond to your request for assistance.

WHIRLPOOL® MICROWAVE OVEN/ RANGE PRODUCT WARRANTY

MW002

LENGTH OF WARRANTY	WHIRLPOOL WILL PAY FOR
FULL ONE-YEAR WARRANTY From Date of Purchase	FSP® replacement parts and repair labor to correct defects in materials or workmanship. Service must be provided by a franchised TECH-CARE® service company.
LIMITED FOUR-YEAR WARRANTY Second Through Fifth Year From Date of Purchase	FSP replacement magnetron tube on microwave ovens if defective in materials or workmanship.
WHIRLPOOL WILL NOT PAY FOR	
<p>A. Service calls to:</p> <ol style="list-style-type: none"> 1. Correct the installation of the range product. 2. Instruct you how to use the range product. 3. Replace house fuses or correct house wiring or plumbing. 4. Replace owner accessible light bulbs. <p>B. Repairs when range product is used in other than normal, single-family household use.</p> <p>C. Pick up and delivery. This product is designed to be repaired in the home.</p> <p>D. Damage to range product caused by accident, misuse, fire, flood, acts of God or use of products not approved by Whirlpool.</p> <p>E. Any labor costs during limited warranties.</p>	

WHIRLPOOL CORPORATION SHALL NOT BE LIABLE FOR INCIDENTAL OR CONSEQUENTIAL DAMAGES. Some states do not allow the exclusion or limitation of incidental or consequential damages so this limitation or exclusion may not apply to you. This warranty gives you specific legal rights, and you may also have other rights which vary from state to state.

Outside the United States, a different warranty may apply. For details, please contact your franchised Whirlpool distributor or military exchange.



Part No. 4B73529A/4158265
©1988 Whirlpool Corporation

Makers. Dishwashers. Built-In Ovens and Surface Units. Ranges. Microwave Ovens. Trash Compactors. Room Air Conditioners. Dehumidifiers. Automatic Washers. Clothes Dryers. Freezers. Refrigerator F.

